

# GP1S39J0000F

Gap : 1.5mm, Detector pitch : 1mm  
2-phase Phototransistor Output,  
Compact Transmissive  
Photointerrupter



## ■ Description

**GP1S39J0000F** is a compact-package, phototransistor output, transmissive photointerrupter, with opposing emitter and detector in a molding that provides non-contact sensing. The compact package series is a result of unique technology combining transfer and injection molding.

This is a 2-phase output device, suitable for detection of rotational/linear speed and direction.

## ■ Features

1. Transmissive with phototransistor output
2. Highlights :
  - Compact Size
  - 2-phase output device
3. Key Parameters :
  - Gap Width : 1.5mm
  - Detector pitch : 1mm (Detecting pitch : TYP. 0.6mm)
  - Package : 4.5×4×3.5mm
4. Lead free and RoHS directive compliant

## ■ Agency approvals/Compliance

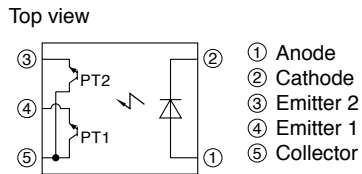
1. Compliant with RoHS directive

## ■ Applications

1. Detection of object presence or motion.
2. Example : printer, lens control for camera

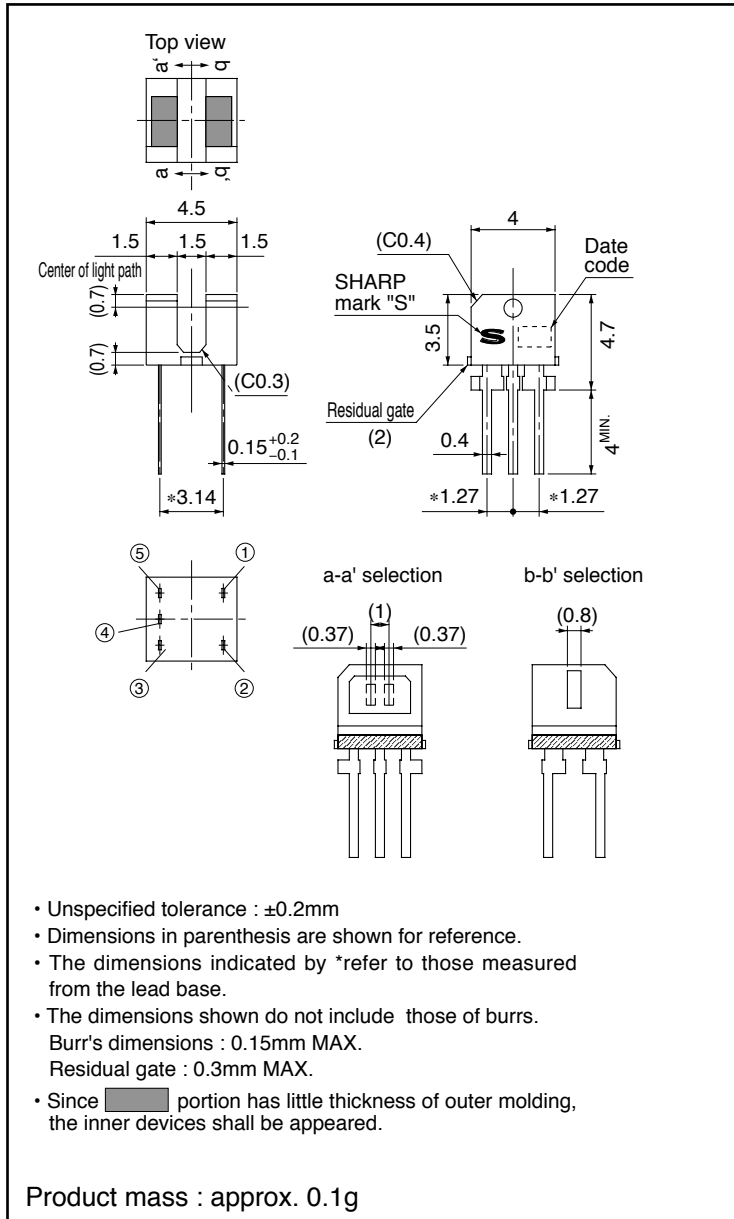
Notice The content of data sheet is subject to change without prior notice.  
In the absence of confirmation by device specification sheets, SHARP takes no responsibility for any defects that may occur in equipment using any SHARP devices shown in catalogs, data books, etc. Contact SHARP in order to obtain the latest device specification sheets before using any SHARP device.

## Internal Connection Diagram



## Outline Dimensions

(Unit : mm)



Plating material : SnCu (Cu : TYP. 2%)

**Date code (2 digit)**

1st digit		2nd digit	
Year of production		Month of production	
A.D.	Mark	Month	Mark
2000	0	1	1
2001	1	2	2
2002	2	3	3
2003	3	4	4
2004	4	5	5
2005	5	6	6
2006	6	7	7
2007	7	8	8
2008	8	9	9
2009	9	10	X
2010	0	11	Y
:	:	12	Z

repeats in a 10 year cycle

**Rank mark**

There is no rank indicator.

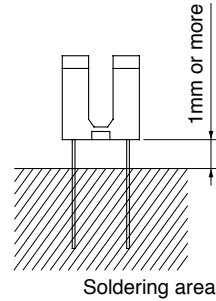
**Country of origin**

Japan

## ■ Absolute Maximum Ratings

 (T<sub>a</sub>=25°C)

Parameter		Symbol	Rating	Unit
Input	Forward current	I <sub>F</sub>	50	mA
	Reverse voltage	V <sub>R</sub>	6	V
	Power dissipation	P	75	mW
Output	Collector-emitter voltage	V <sub>CE10</sub>	35	V
		V <sub>CE20</sub>		
	Emitter-collector voltage	V <sub>E1CO</sub>	6	V
		V <sub>E2CO</sub>		
	Collector current	I <sub>C</sub>	20	mA
	Collector power dissipation	P <sub>C</sub>	75	mW
Total power dissipation		P <sub>tot</sub>	100	mW
Operating temperature		T <sub>opr</sub>	-25 to +85	°C
Storage temperature		T <sub>stg</sub>	-40 to +100	°C
*1 Soldering temperature		T <sub>sol</sub>	260	°C



\*1 For 5s or less

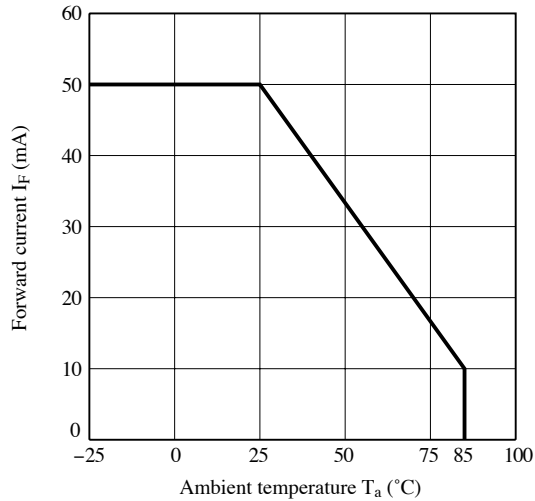
## ■ Electro-optical Characteristics

 (T<sub>a</sub>=25°C)

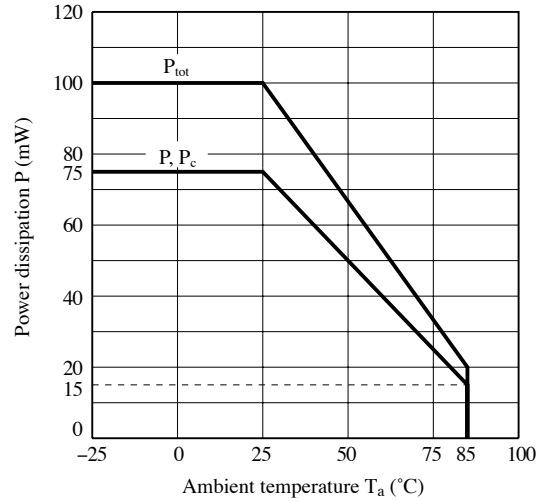
Parameter		Symbol	Condition	MIN.	TYP.	MAX.	Unit	
Input	Forward voltage	V <sub>F</sub>	I <sub>F</sub> =20mA	-	1.2	1.4	V	
	Reverse current	I <sub>R</sub>	V <sub>R</sub> =3V	-	-	10	μA	
*2 Output	Collector dark current	I <sub>CEO</sub>	V <sub>CE</sub> =20V	-	-	100	nA	
*2 Transfer characteristics	Collector current	I <sub>C</sub>	V <sub>CE</sub> =5V, I <sub>F</sub> =4mA	130	-	520	μA	
	Collector current ratio	I <sub>C1</sub> /I <sub>C2</sub>	V <sub>CE</sub> =5V, I <sub>F</sub> =4mA	0.67	-	1.5	-	
	Collector-emitter saturation voltage	V <sub>CE(sat)</sub>	I <sub>F</sub> =8mA, I <sub>C</sub> =50μA	-	-	0.4	V	
	Response time	Rise time	t <sub>r</sub>	V <sub>CE</sub> =5V, I <sub>C</sub> =100μA, R <sub>L</sub> =1kΩ	-	50	150	μs
		Fall time	t <sub>f</sub>		-	50	150	μs

\*2 Output and Transfer characteristics are common to both phototransistors

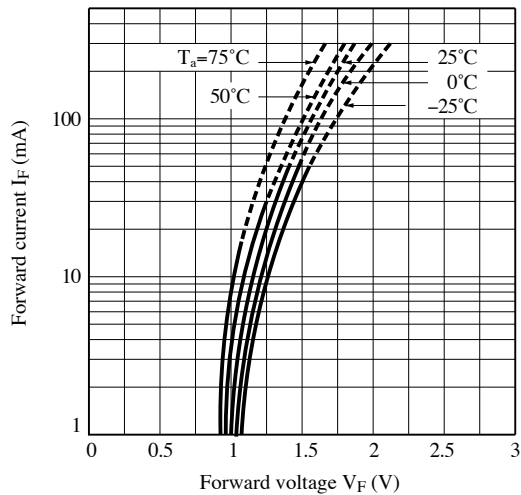
**Fig.1 Forward Current vs. Ambient Temperature**



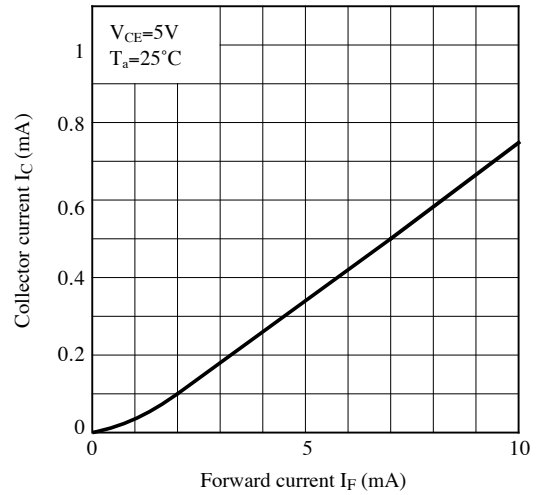
**Fig.2 Power Dissipation vs. Ambient Temperature**



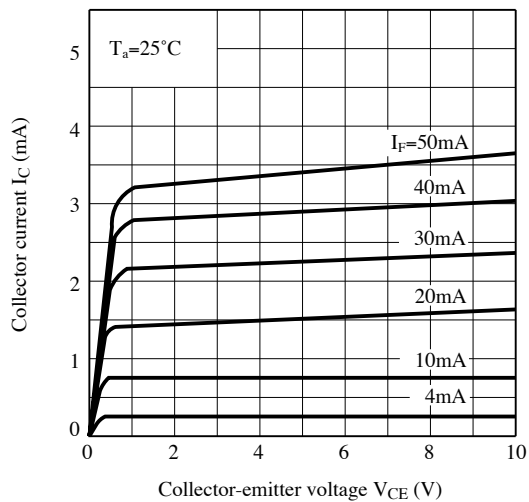
**Fig.3 Forward Current vs. Forward Voltage**



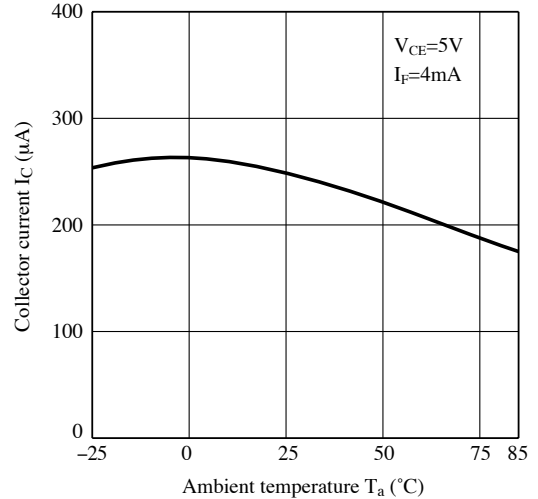
**Fig.4 Collector Current vs. Forward Current**



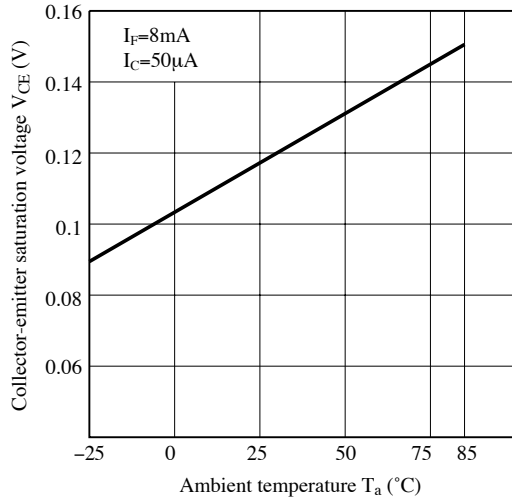
**Fig.5 Collector Current vs. Collector-emitter Voltage**



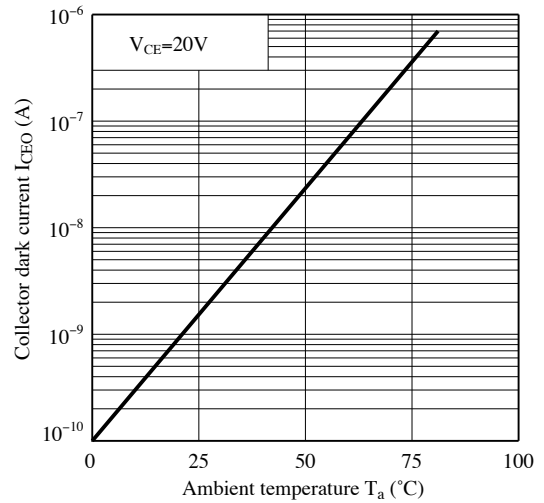
**Fig.6 Relative Collector Current vs. Ambient Temperature**



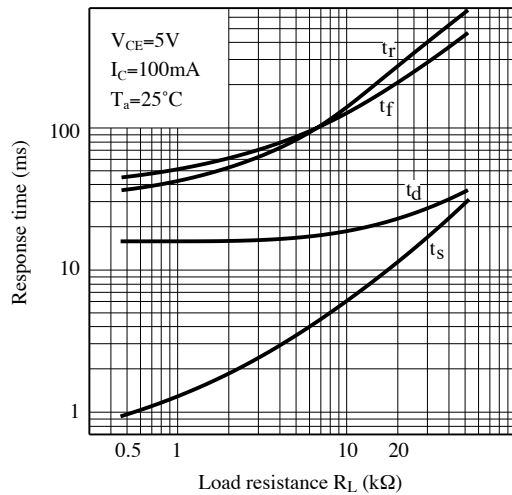
**Fig.7 Collector-emitter Saturation Voltage vs. Ambient Temperature**



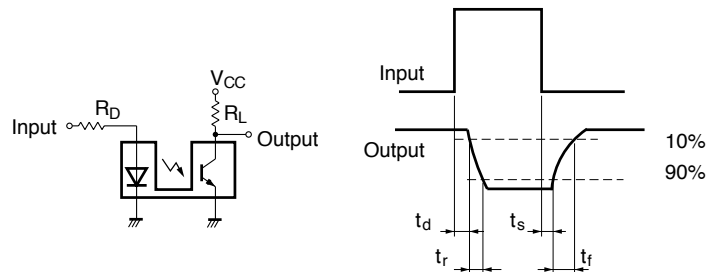
**Fig.8 Collector Dark Current vs. Ambient Temperature**



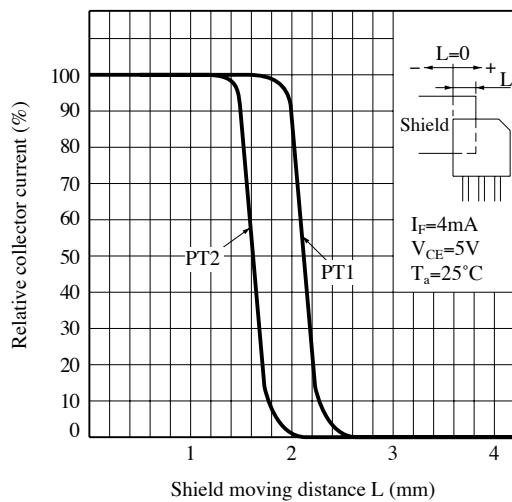
**Fig.9 Response Time vs. Load Resistance**



**Fig.10 Test Circuit for Response Time**

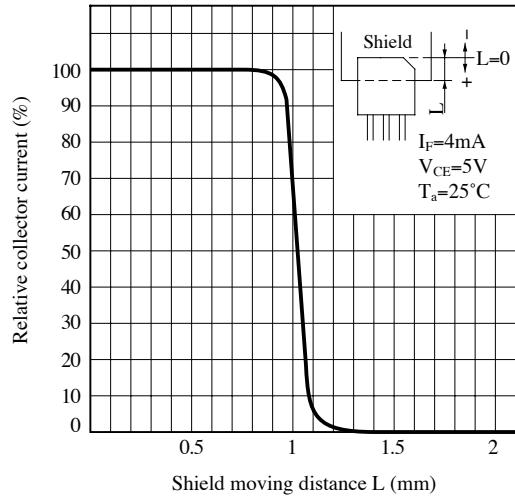


**Fig.11 Detecting Position Characteristics (1)**  
(Output of PT1 and PT2 are 100% at L=0)



Parameter	TYP.	Unit
PT2 detection width : L1	0.3	mm
PT1 detection width : L2	0.3	
Distance between detection positions : L3	0.6	

**Fig.12 Detecting Position Characteristics (2)**  
**(Output of PT1 and PT2 are 100% at L=0)**



Remarks : Please be aware that all data in the graph are just for reference and not for guarantee.

## ■ Design Considerations

### ● Design guide

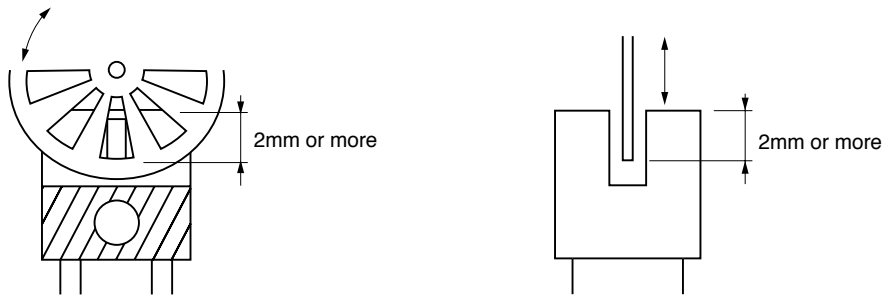
1) Prevention of detection error

To prevent photointerrupter from faulty operation caused by external light, do not set the detecting face to the external light.

2) Position of opaque board

Opaque board shall be installed at place 2mm or more from the top of elements.

(Example)



This product is not designed against irradiation and incorporates non-coherent IRED.

### ● Degradation

In general, the emission of the IRED used in photointerrupter will degrade over time.

In the case of long term operation, please take the general IRED degradation (50% degradation over 5 years) into the design consideration.

### ● Parts

This product is assembled using the below parts.

• Photodetector (qty. : 2)

Category	Material	Maximum Sensitivity wavelength (nm)	Sensitivity wavelength (nm)	Response time (μs)
Phototransistor	Silicon (Si)	930	700 to 1 200	20

• Photo emitter (qty. : 1)

Category	Material	Maximum light emitting wavelength (nm)	I/O Frequency (MHz)
Infrared emitting diode (non-coherent)	Gallium arsenide (GaAs)	950	0.3

• Material

Case	Lead frame	Lead frame plating
Black polyphernylene sulfide resin (UL94 V-0)	42Alloy	SnCu plating



**■ Manufacturing Guidelines****● Soldering Method**

## Flow Soldering:

Soldering should be completed below 260°C and within 5 s.

Please solder within one time.

Soldering area is 1mm or more away from the bottom of housing.

Please take care not to let any external force exert on lead pins.

Please don't do soldering with preheating, and please don't do soldering by reflow.

## Hand soldering

Hand soldering should be completed within 3 s when the point of solder iron is below 350°C.

Please solder within one time.

Please don't touch the terminals directly by soldering iron.

Soldered product shall treat at normal temperature.

## Other notice

Please test the soldering method in actual condition and make sure the soldering works fine, since the impact on the junction between the device and PCB varies depending on the cooling and soldering conditions.

**● Cleaning instructions**

## Solvent cleaning :

Solvent temperature should be 45°C or below. Immersion time should be 3 minutes or less.

## Ultrasonic cleaning :

Do not execute ultrasonic cleaning.

## Recommended solvent materials :

Ethyl alcohol, Methyl alcohol and Isopropyl alcohol.

**● Presence of ODC**

This product shall not contain the following materials.

And they are not used in the production process for this product.

Regulation substances : CFCs, Halon, Carbon tetrachloride, 1.1.1-Trichloroethane (Methylchloroform)

Specific brominated flame retardants such as the PBBOs and PBBs are not used in this product at all.

This product shall not contain the following materials banned in the RoHS Directive (2002/95/EC).

•Lead, Mercury, Cadmium, Hexavalent chromium, Polybrominated biphenyls (PBB), Polybrominated diphenyl ethers (PBDE).

**■ Package specification****● Sleeve package**

## Package materials

Sleeve : Polystyrene

Stopper : Styrene-butadiene

## Package method

MAX. 40 pcs. of products shall be packaged in a sleeve. Both ends shall be closed by tabbed and tabless stoppers.

MAX. 50 sleeves in one case.

**■ Important Notices**

· The circuit application examples in this publication are provided to explain representative applications of SHARP devices and are not intended to guarantee any circuit design or license any intellectual property rights. SHARP takes no responsibility for any problems related to any intellectual property right of a third party resulting from the use of SHARP's devices.

· Contact SHARP in order to obtain the latest device specification sheets before using any SHARP device. SHARP reserves the right to make changes in the specifications, characteristics, data, materials, structure, and other contents described herein at any time without notice in order to improve design or reliability. Manufacturing locations are also subject to change without notice.

· Observe the following points when using any devices in this publication. SHARP takes no responsibility for damage caused by improper use of the devices which does not meet the conditions and absolute maximum ratings to be used specified in the relevant specification sheet nor meet the following conditions:

(i) The devices in this publication are designed for use in general electronic equipment designs such as:

- Personal computers
- Office automation equipment
- Telecommunication equipment [terminal]
- Test and measurement equipment
- Industrial control
- Audio visual equipment
- Consumer electronics

(ii) Measures such as fail-safe function and redundant design should be taken to ensure reliability and safety when SHARP devices are used for or in connection

with equipment that requires higher reliability such as:

- Transportation control and safety equipment (i.e., aircraft, trains, automobiles, etc.)
- Traffic signals
- Gas leakage sensor breakers
- Alarm equipment
- Various safety devices, etc.

(iii) SHARP devices shall not be used for or in connection with equipment that requires an extremely high level of reliability and safety such as:

- Space applications
- Telecommunication equipment [trunk lines]
- Nuclear power control equipment
- Medical and other life support equipment (e.g., scuba).

· If the SHARP devices listed in this publication fall within the scope of strategic products described in the Foreign Exchange and Foreign Trade Law of Japan, it is necessary to obtain approval to export such SHARP devices.

· This publication is the proprietary product of SHARP and is copyrighted, with all rights reserved. Under the copyright laws, no part of this publication may be reproduced or transmitted in any form or by any means, electronic or mechanical, for any purpose, in whole or in part, without the express written permission of SHARP. Express written permission is also required before any use of this publication may be made by a third party.

· Contact and consult with a SHARP representative if there are any questions about the contents of this publication.